

Mobile Photovoltaic Power Generators for out-door living

Mitko Stoev

Solar Energy Centre
Faculty of Mathematics and Natural Sciences
South-West University "Neofit Rilski"
Blagoevgrad, BULGARIA

E-mail: mstoev@mail.bg

Agenda

- **Mobile Fossil fuel and PV powered generators**
- **Type of RE systems**
- **Stand alone PV generators**
- **Types of Mobile PV powered generators**
 - **70 Wp, 140 Wp and 350 Wp SWU transportable PV generators**

Fossil fuel powered generators

- Sewer and water facilities
- Hospitals
- Emergency operating centres: **several hundred kilowatts (kW) of emergency power**

Types of RE Systems

- Fixed RE systems
- Portable RE systems

Portable PV systems

- **Easy to transport**
- **Solar energy is plentiful in many regions**
- **Self sufficiency**
 - **no fuel**
- **a very little maintenance**

Stand-alone PV generators

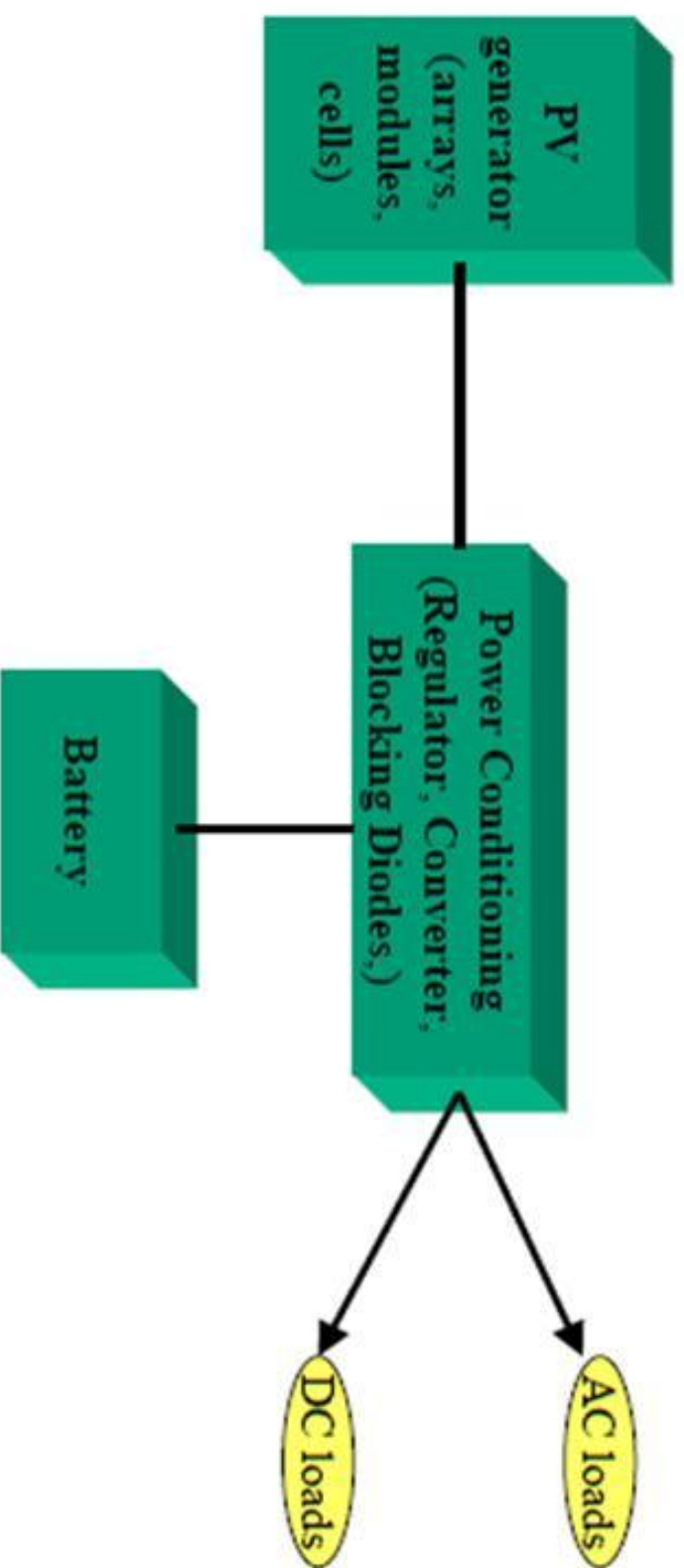

Block diagram for the stand-alone PV system

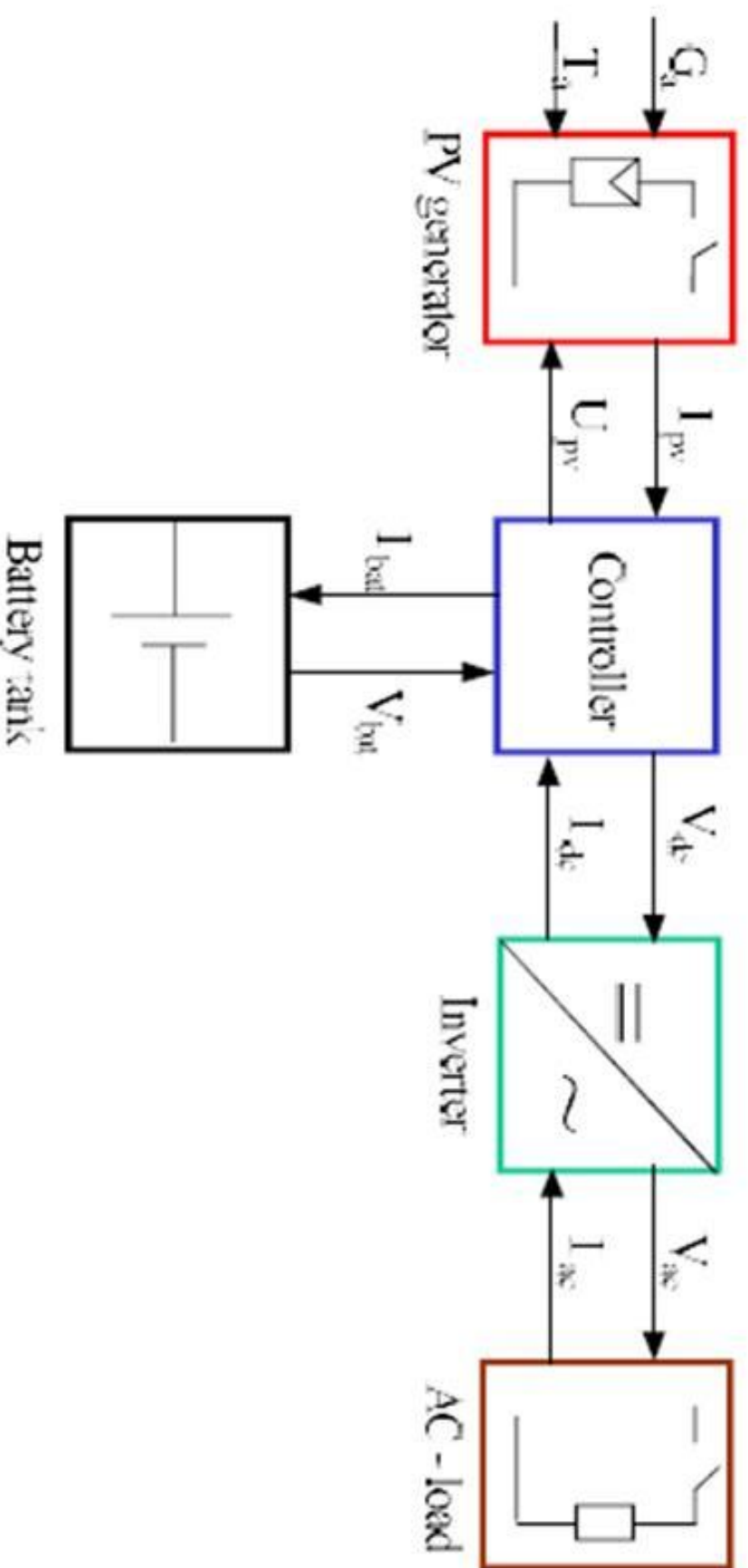

A typical current-voltage I-V curve for a solar cell

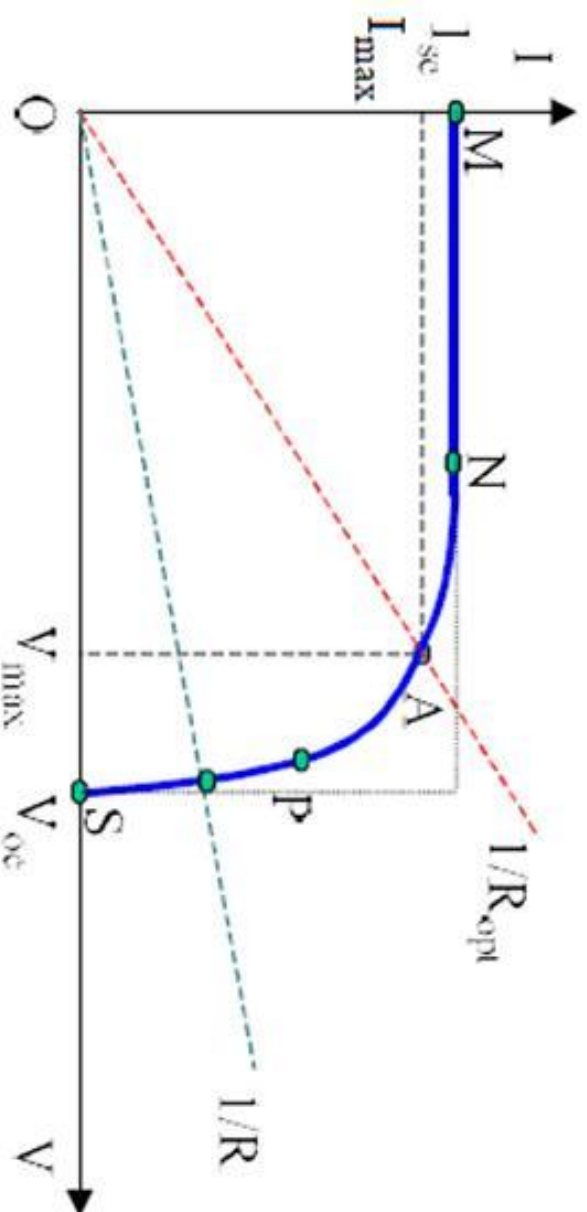

Influence of ambient irradiation (a) and of the cell temperature (b) on the cell characteristics

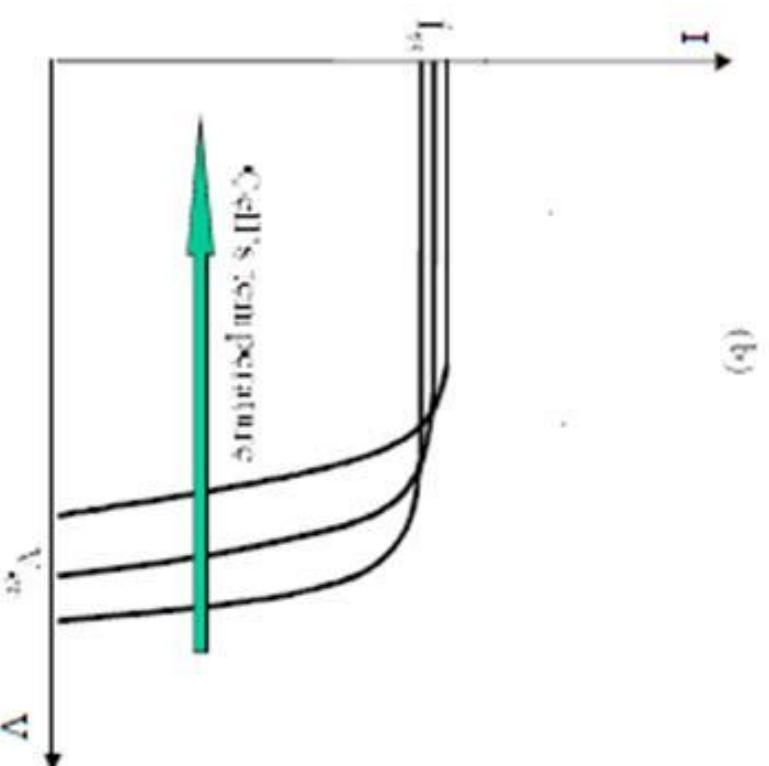
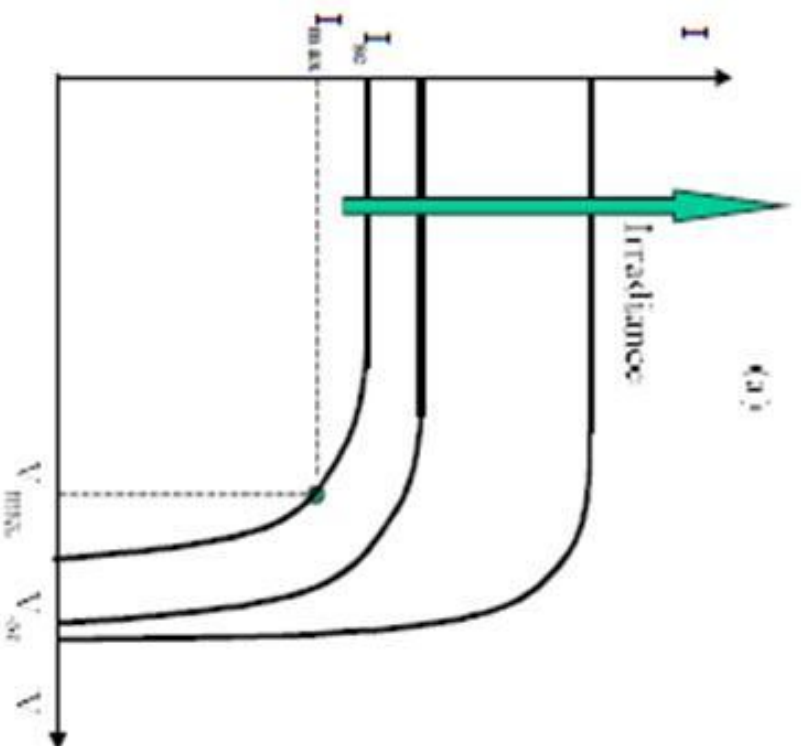

**PV module: N_{PM} parallel branches;
 N_{SM} solar cells in series**

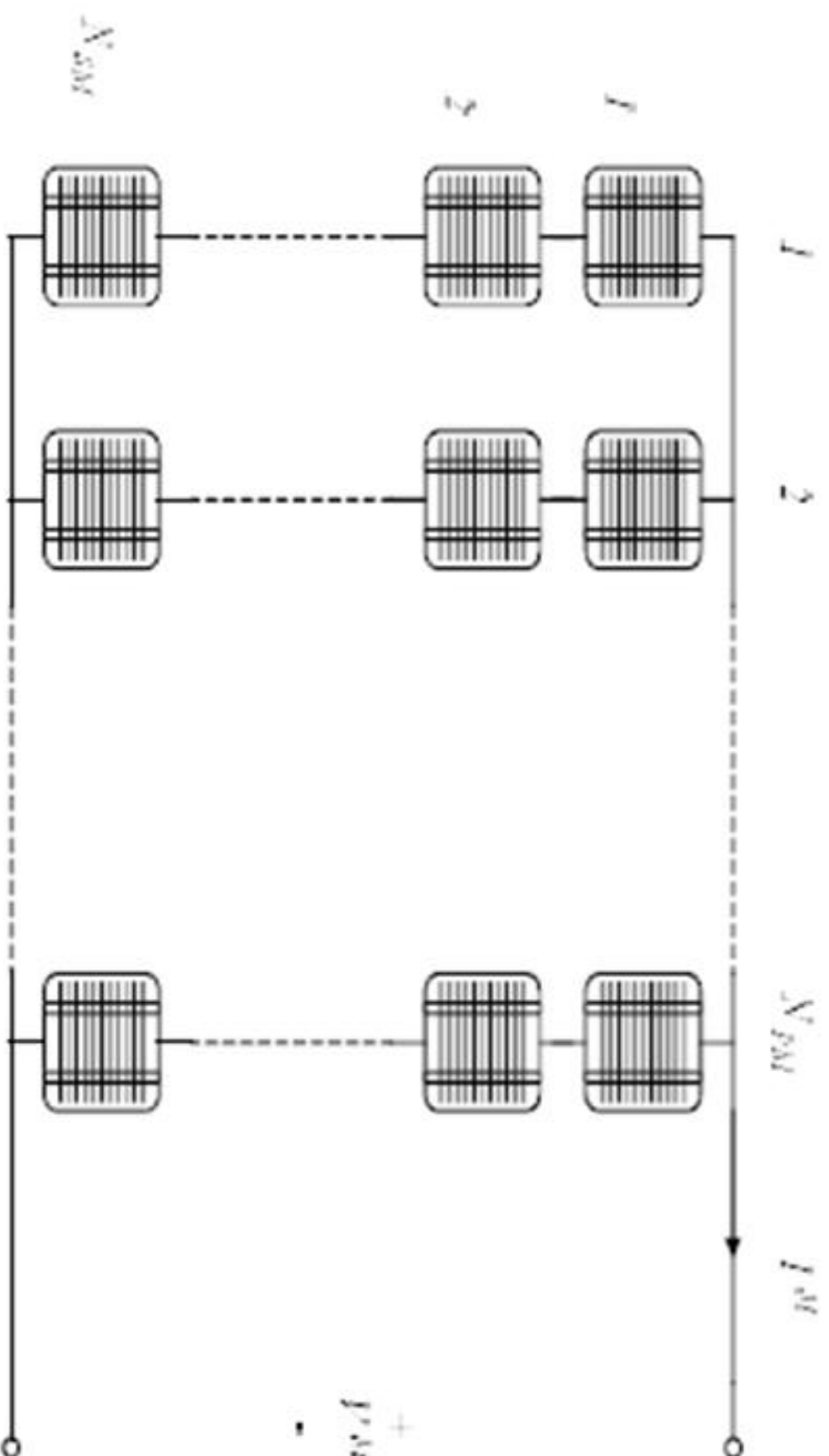

Technical Characteristics of Mobile PV generator

- PV panels: **20-25 years warranty**, 30-40 years productivity
- Charge controllers
- Lead-acid batteries: Every three weeks a full charge. **Every three months equalization. 7 – 10 years warranty**
- Inverters: pure sine wave power; modified sine wave power; recharging the battery bank rapidly, **2 years warranty**
- Tower trailer
- Hybrid models: propane or diesel backup generators, biodiesel option
- Price: 10 000 – 100 000 USD
- Payback time: 2 years

Requirements

- PV panels
- Batteries: deep cycle Pb-acid, Li-ion, Ni-Zn
- 24 Vdc battery bank
- 9,3 – 45 kWh (390 – 1880 Ah)
- 20 hr discharge rate
- Charge controller
- **to run large loads for short periods of time**

Sizing Mobile PV generator

- Equipment power demands
- Power output from the solar array
- Amount of the battery backup
- Amount of inverter power requirement

Benefits

- **Environmentally responsible**
- **Silent alternative to the diesel or gasoline generators**

EnviroDyne Energy system: 2 – 10 kWp



Open trailer design of Mobile PV generator







Mobile Photovoltaic Solar Power Generator 230V 6KW













Mobile Photovoltaic Power Generator: Protected trailer



















First Lithium (LiFeMgPO₄) Solar Generator













Idaho National Laboratory, Mobile Grid-Tie System

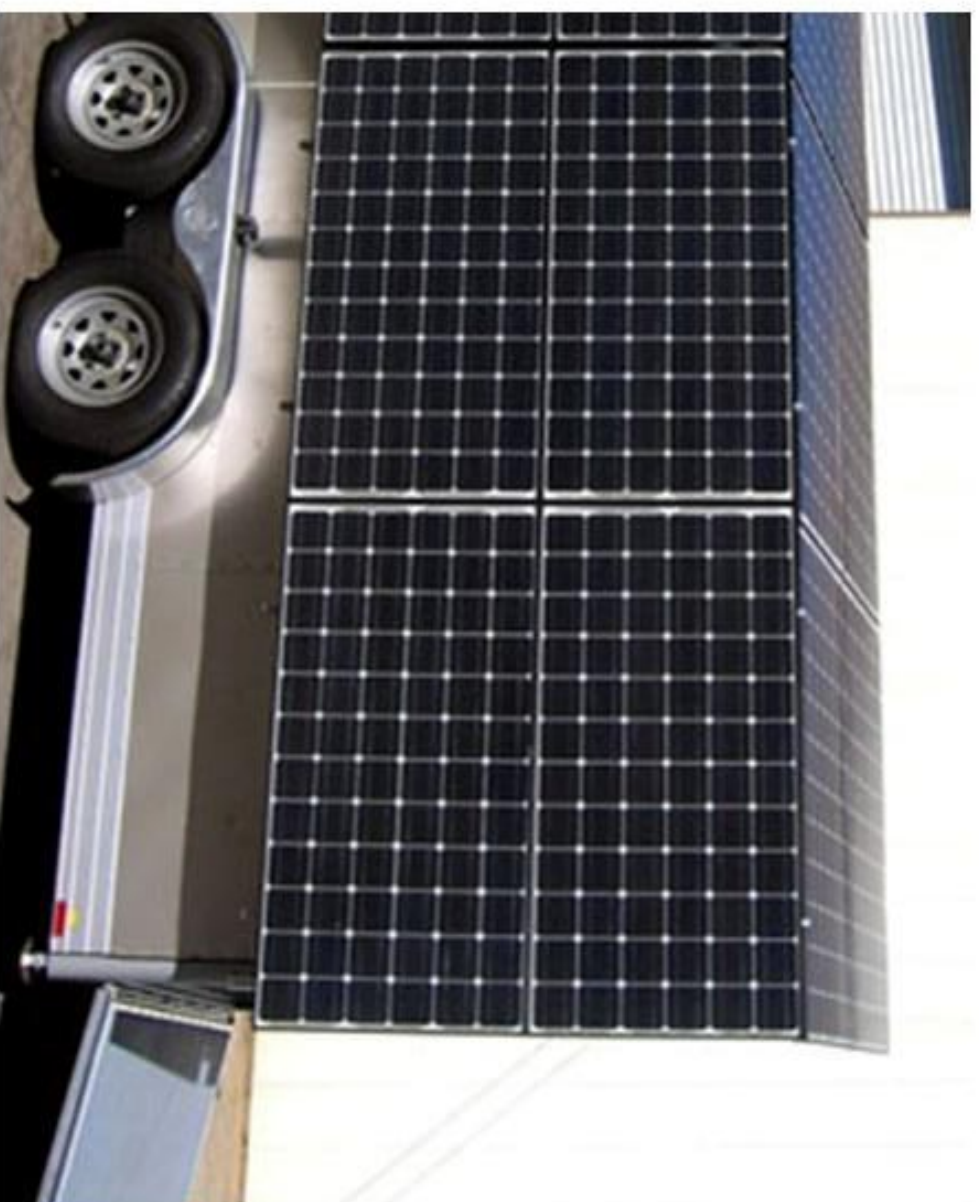

Specification

- Solar: 16 Sanyo 210-watt modules – total array: **3.36kW**
- Battery: **1,568AH** at 24VDC
- Inverter: **7KW** pure sine-wave, grid-tie capable

Verizon Wireless - Mobile Cell Station



Specification

- Solar: 9 Suntech 175-watt modules – total array: **1.58kW**
- Battery: **1,150Ah** at 24VDC
- Inverter: **3.5kW** pure sine-wave

U.S. Air Force Reserve, Savannah, GA



Specification

- Solar: 16 Sanyo 190-watt modules, total array: **3.04kW**
- Battery: **1,568Ah** at 24VDC
- Inverter: **7kW** pure sine-wave
- Diesel Genset: **5kW** Onan HDKBC

U.S. Army





Mobile PV generators and technology against Improvised Explosive Devices in Iraq

- **Solar: 4 Suntech 175-watt modules, total array: 700 watts**
- **Battery: 800 Ah at 24VDC**
- **Inverter: 3.5 kW pure sine-wave**

Solar Energy Centre, South-West University “Neofit Riski”, Blagoevgrad, BULGARIA

Mobile PV systems for out-door living:

- **70 Wp PV:** Integrated PV generator into the car structure (CIPV)
- **140 Wp PV:** Integrated PV generator into the car structure (CIPV)
 - Integration of PV into the car roof for a road structure
 - Integration of PV into the jeep 4X4 roof structure for an off-road destinations in isolated locations
- **350 Wp PV:** transportable PV generators by a car

140 Wp CIPV mounted system on the roof of Lada Niva SOLAR



Lada Niva SOLAR for off-road destinations



Demonstration of PV technology for outdoor living in isolated locations



PV rack for 350 Wp PV portable generator



Installation of the first PV module: mc-Si, 70 Wp



350 Wp PV transportable generator





Black Sea SOLAR CAMP with 350 Wp PV



350 Wp PV on the beach



Applications of mobile PV generators

- The construction jobsites
- Lighting
- Computers
- Heaters
- Skill saws
- Grinders
- Compressors
- Hand tools
- Off-grid power requirements
- Emergency Power Sources
- Water purification
- Water pumping
- Remove monitoring

Application of Mobile PV generator



Thank for your attention

